

Bubbler Classic Pro 1x18 lt, R290



**Ref: CC0H5G
(SR1D22290FEUSPM)**

Cold beverage dispenser - Classic Pro 1x18 lt, with new easy-off release bowl and high efficiency cooling system

General Features

CLASSIC PRO 1x18 is an appealing cold drink dispenser, ideal for high daily consumption contexts, thanks to its large tank of 18 liters capacity.

This equipment refreshes and dispenses ready-made drinks to be poured inside the bowl such as fresh juices, teas, cold coffees, cocktails, flavored water etc..

Transparent bowls give this equipment a highly attractive appeal.

The unique evaporator and the high efficiency pump cool faster and more efficiently for a quick start-up. The superior engineering ensures a perfect temperature from the first to the last drop of dispensed product.

Two-piece dripless pouring valves are easy to use and clean. Suitable for cups up to 8 inch height (22,9 cm).

Drinks stirring by a magnetic submerged impeller. Agitators are provided with each unit,

Panels and drip tray available in stainless steel.

OPTIONALS AVAILABLE

- VALVE CAP: Improves sealing of valve when using pulpy product
- FOUNTAIN SPRAY KIT: ideal to create a spectacular effect

Bubbler Classic Pro 1x18 lt, R290

Specifications

- Suitable for cups up to 8 inch height (20 cm)
- Easy-off bowl release system for faster and easier assembly and disassembly.
- User friendly design enables machine to dispense product till the very last drop.
- Agitation function, with low foam impeller cover special for fresh juices, coffees, vitamin water or tea.
- Appealing cold drink dispenser equipped with 1 bowl, 18 litres capacity

Construction

- Magnetic submerged impeller
- Refrigerant type: R290.
- Pre-mix dispenser with stainless steel base and clear plastic bowls.
- The air intakes from the bottom and exhaust to back.

Bubbler Classic Pro 1x18 lt, R290

Electric

Supply voltage:	220-240 V / 1N ph / Hz
Electrical power max.:	0.4 kW
Current consumption:	1.5 Amps
Plug type:	CE-SCHUKO

Key Information:

Number of bowls:	1
Bowl's capacity:	18 lt
Dimensions, Width:	270 mm
Dimensions, Depth:	450 mm
Dimensions, Height:	790 mm
Net weight:	25.4 kg

Refrigeration Data

Refrigerant gas:	R290
------------------	------

Certifications



The company reserves the right to make modifications to the products without prior notice. All information correct at time of printing.

2025.03.11

Front

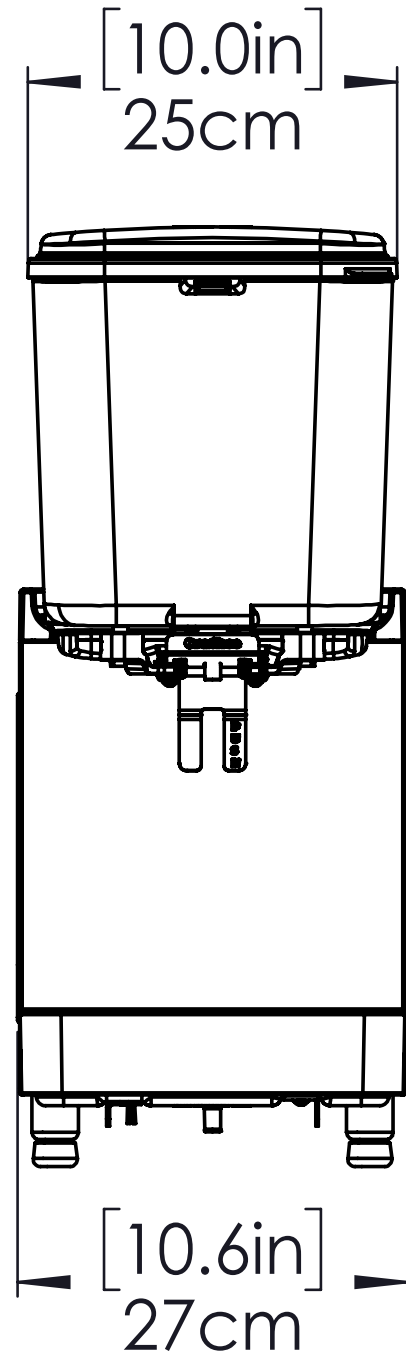

SPM

www.spm.drink-systems.com
infospm@electroluxprofessional.com